

# FunCube Dongle Pro+ V2.0 on Shortwave

© 2013: Nils Schiffhauer, DK8OK

*AMSAT-UK's FunCube Dongle Pro+ V2.0 (simply "FCD" in this paper) provides a software-defined radio in just an USB stick. This paper shows a few aspects of what can be expected and actually received and decoded with it in combination with free software.*

Shortwave listening is said to be expensive, complicated and frustrating. Software-defined radios (SDRs) have changed this game dramatically: This paper's approach is to show how cheap it can be by state-of-the-art hardware and how much can be heard/decoded using free software.

You should be a bit familiar with FunCube Dongle and some software, for I will concentrate on examples and not trying to echo a manual or lengthy (test) reports. But you may find some aspects of both also on the following pages.

## Easy Start

What do we need?

- FunCube Dongle Pro+, Version 2.0, which can

be ordered from this [website](#), at a basic price tag of under 150 Euro plus VAT and postage. I was billed 163,19 British Pounds including all expenditures (190 Euro).

- A computer which can be a small and rather cheap laptop.
- Some software to fire up the FCD.
- Some additional software for more fun.

As software controlling the FCD, I will use e.g. [SDR#](#), [SDR-Radio V2.0](#) and [HSDR](#). For some side-by-side comparisons, [Winradio's ExcaliburPRO](#) is used (1900 Euro). Antenna is a vertical loop of 20 meters circumference, powered by [Wellbrooks ALA100](#). It ends in a passive antenna splitter by Heros, namely it's [VLF version](#). This one is feeding both receivers in parallel for comparisons. You don't need that if using FCD standalone.

First, I will give a short overlook of what can be expected, and on how to avoid some common mistakes. Then I will proceed with broadcast, amateur radio and utility reception.

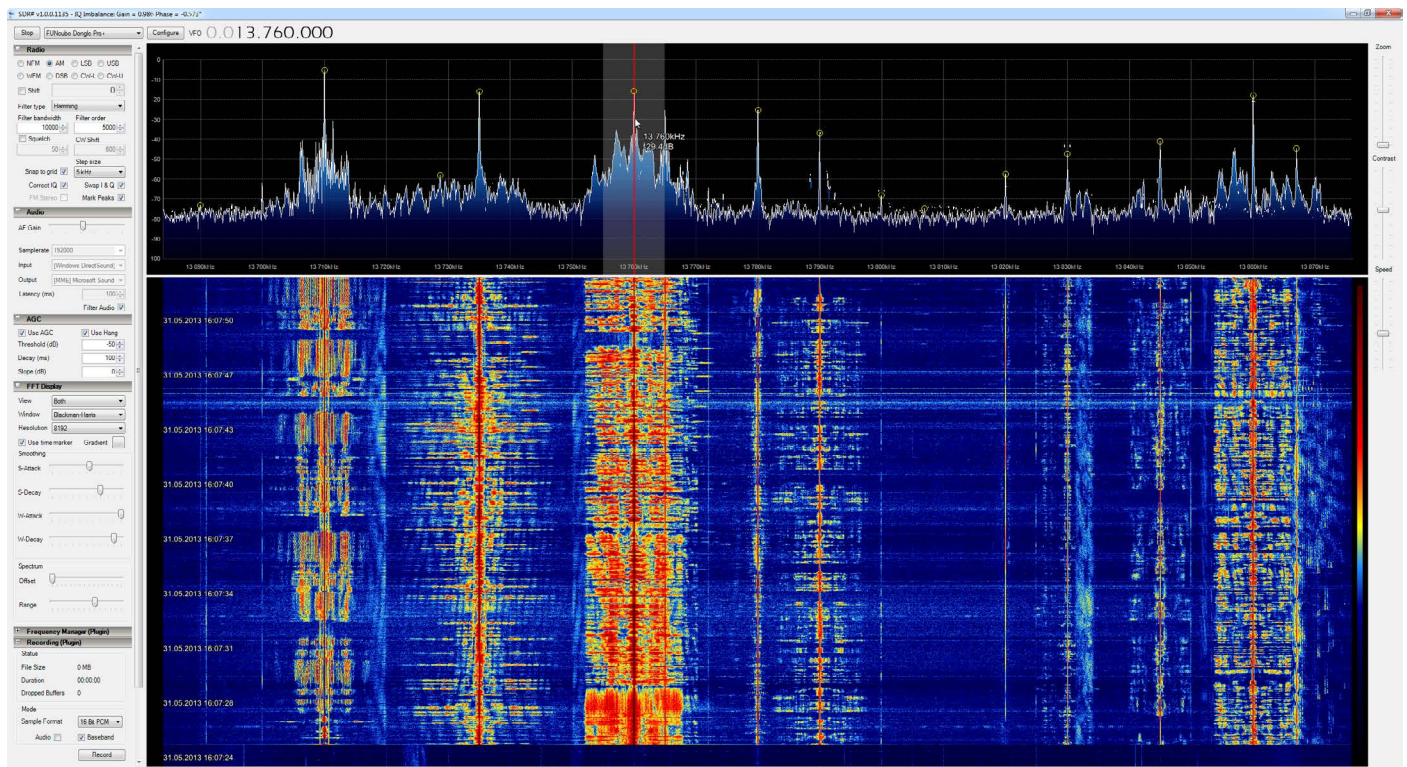

Figure 1: A look into the broadcast band at 13 MHz with SDR# ("SDR sharp"). On the top you see the spectrum, its peaks automatically marked. Below is the sonagram, or "waterfall". Time stamps have some menus to control e.g. mode, bandwidth, AGC, tuning steps etc.



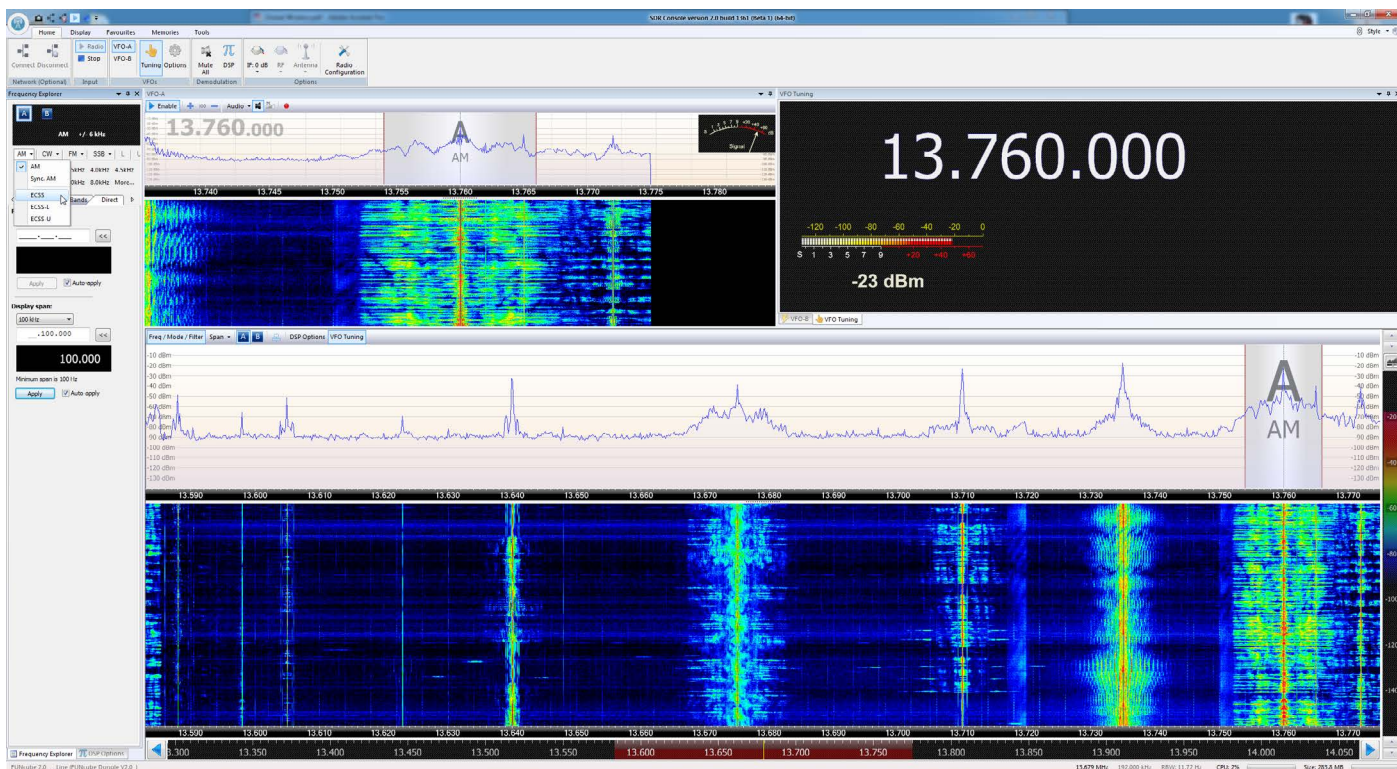

Figure 2: Similar situation as in Figure 1, but seen here by software SDR-Software V2.0. This is more elaborated in many aspects, hence needing a bit more time to enjoy all of its features.

## Dynamic Range

One of the biggest challenge for a receiver is to offer a wide dynamic range. This is the capability to receive weak and strong signals in one “band” without adverse effects. If you have a good antenna, you need a dynamic range of about 140 dB on shortwave to not receive any ghost signals. High-end receivers, being in the price range of shortwave listeners, are just above 100 dB (ExcaliburPRO: 107 dB).

Although the dynamic range of the FCD isn’t specified, it’s much lower. There are octave filters to improve the situation, but at broadband antennas and in the dawn periods with strong sum signals on shortwave, you will easily experience distortion – see Figure 3. These must be fought by reducing the hardware amplification of FCD by LNA, Mixer Gain and IF Gain in the menu “FUNCube Plus Options” – see Figure 4. If the problem persists, you might need an external attenuator or preselector, e.g. by Heros.

**Always keep in mind: You don’t need the strongest signals, but the best signal-to-noise-ratio! This is the somewhat hidden secret on how to get the best results from any radio!**

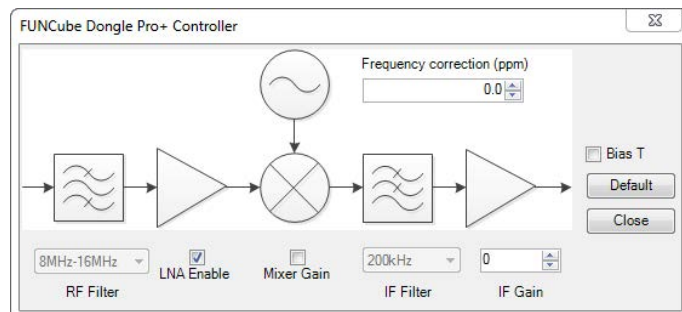

Figure 4: The “Configure” menu in SDR# shows this block diagram of the input of FCD. Here you can control the dynamic range and its position within the whole range: “RF Filter” is automatically set. Enable/adjust Low Noise Amplifier LNA, Mixer Gain and IF Gain for the best signal-to-noise ratio SNR. Start with disabled them all, and then enable them from left to right. In 80 % of the cases, this work flow should result in the best SNR.

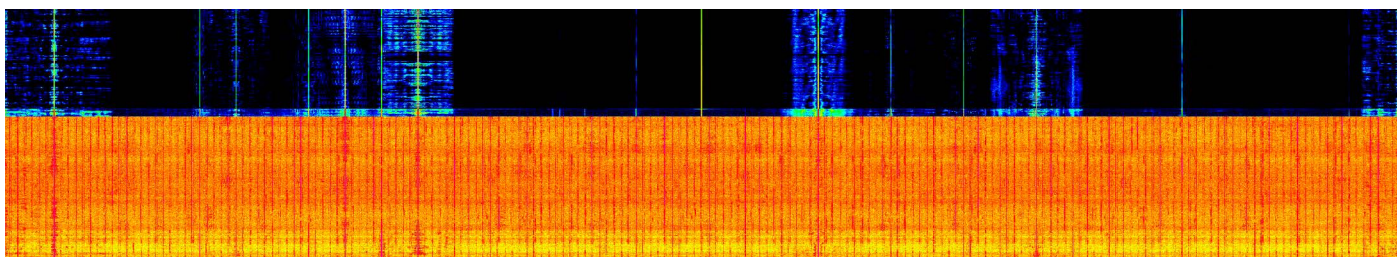

Figure 3: The lower part of this sonagram shows heavy distortion by clipping. In the upper part, amplification has been reduced to a level that provides clear signals over a long period in an even cluttered band.



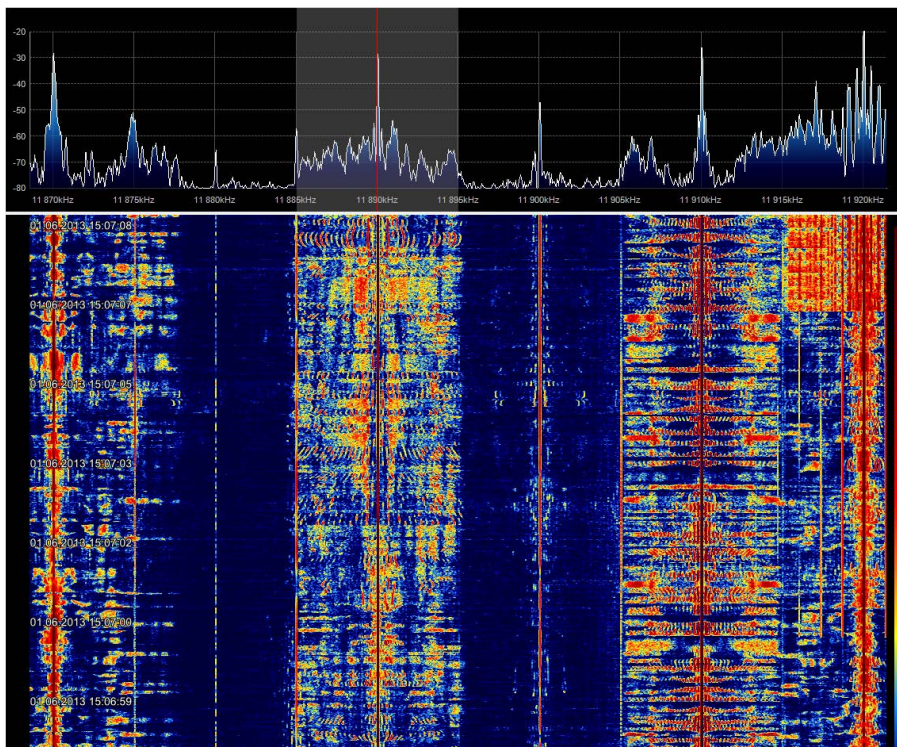

Figure 5: Each broadcast is clearly marked by its carrier which is seen by the peak in the upper spectrum. The lower sonagram in turn tells much about the quality of modulation: wide or narrow, high dynamic or low modulation.

## Broadcast

Shortwave broadcast still is a valuable vehicle for transmitting information, propaganda, religious beliefs and even just music. As each broadcaster tries to optimize reception in a specific target region, most signals of international broadcasters are strong and not too much distorted. It's an ideal field for beginners.

On the other part of the spectrum, we find many stations just providing a small region, e.g. in Indonesia, Peru or India. Their reception outside these areas often provides some challenges due to low signals, unfavorable conditions at their actual transmitting times, low modulation at the transmitter or all together, plus interference.

Nearly all broadcasters are transmitting in AM, amplitude modulation. It consists of a carrier and two

mirrored sidebands carrying speech and music. Bandwidth is 10 kHz, with some transmitters being wider and many smaller. The technical quality of modulation at the transmitter's site widely differs from a perfect sound to highly distorted audio where literally nothing can be understood.

Figure 5 gives an impression out of the 25 meter band. The sonagram shows as widest modulation about 10 kHz, whereas the smallest distance from carrier to carrier counts just 5 kHz. Frequency planning tries to minimize interference. This gives DXers a chance to chase these "in between" stations. Figure 6: Some examples, for which I took recordings of the same frequency range and station with both, FCD and ExcaliburPRO for comparison. They are separated by a small pause. All have been recorded in AM, tuned to the nominal frequency, bandwidth 7,5 kHz and AGC slow as WAV file, converted into MP3.

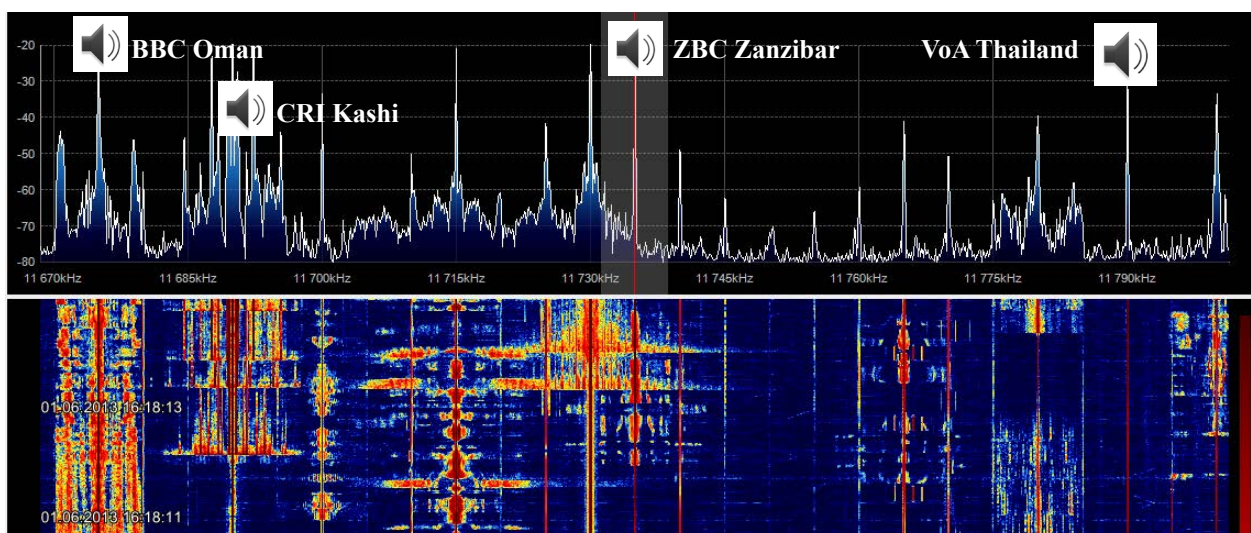

Figure 6: Click, listen and compare! First FCD, then Winradio.



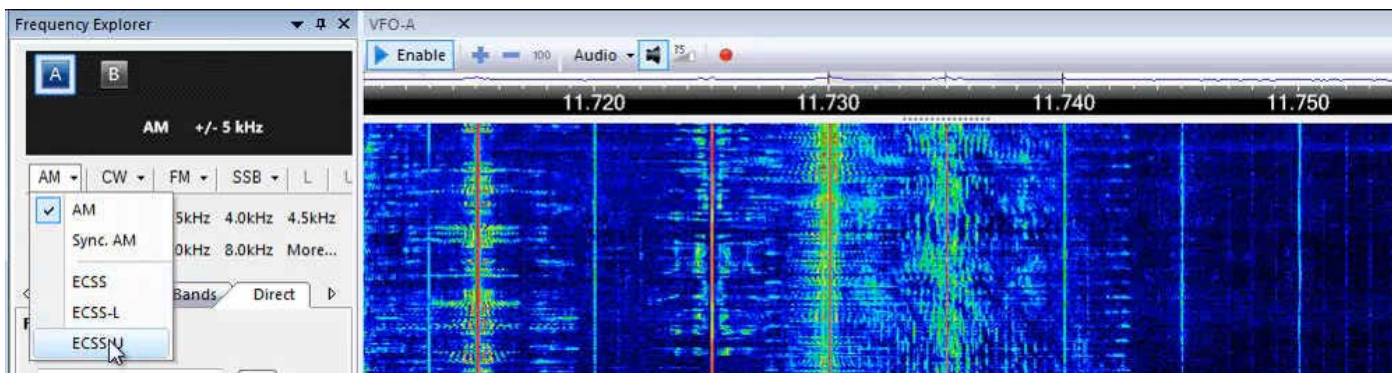

Figure 7 (video, click!): For AM reception, ECSS is the preferred method. You can choose the less interfered sideband, and you get rid of mainly all distortion caused by selective fading. This example shows how to optimize reception of ZBC Zanzibar 11.735 kHz. First in AM with 10 kHz bandwidth, where you hear only traces of the signal due to interference from below. Then switching to ECSS/USB to reduce that interference and to use a wider bandwidth than with symmetrically tuning in AM. There is also a comparison to AM with 5 kHz bandwidth to show the loss in higher audio frequencies.

There is nothing special about broadcast reception. But you can optimize it significantly by ECSS or exalted carrier single sideband reception. There, the carrier of the received signal is substituted by an internally synchronized carrier so that you can switch to the bandwidth of lesser interference. As welcomed side effect, you not only get rid of most interference, but also of distortion by selective fading. This has its reason in the nonconstructive mixture of both sidebands in a conventional AM demodulator. The video (Figure 7) gives a striking example.

### Digital Shortwave: DRM

DRM is a 10 kHz wide OFDM mode which has been developed to substitute AM modulation on shortwave.

Even after more than twelve years of heavy funding it suffers from the hen-and-egg-problem: industry isn't producing (cheap) receivers, because there are only

some broadcasts in this mode, and broadcasters do see DRM with some reluctance because there are no receivers. But with your FCD and free software like SoDiRa (direct, see Figure 8) or DREAM (via SSB, see following steps) reception is no problem:

- Switch your control software to USB and change bandwidth to 12 kHz
- Tune your receive to the nominal frequency, minus 6 kHz (the half of 12 kHz). The DRM station should be in the center of the passband.
- Now you must feed this audio to the input of the DRM software and switch the output of the DRM software to your playback device (loudspeaker). This works best with a "virtual soundcard", otherwise you hear the noise of the undecoded signal and the decoded DRM transmission in one noisy audio channel.

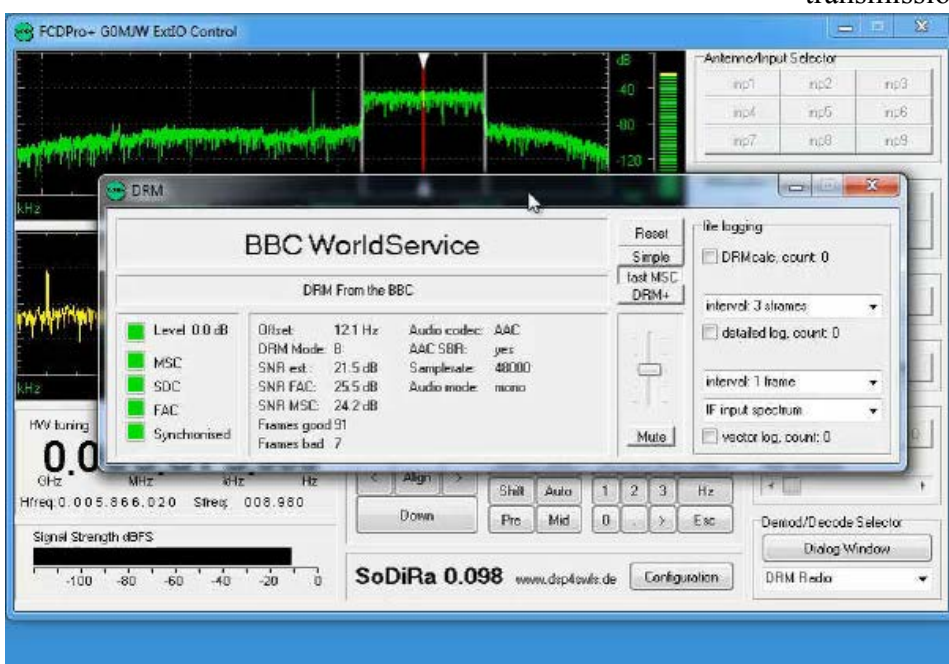

Figure 8 (video, click!): Reception with SoDiRa. First a short portion of AM broadcast, switching from envelope detector to Synchronous AM to avoid selective fading. Then directly tuning the FCD by the keypad of SoDiRa to BBC's DRM broadcast on 5.875 kHz, and decoding.



## Amateur Radio

Amateur or Ham Radio is a hobby. With powers usually between one watt and 1000 watts “hams” do communicate in a number of modes within their bands. As receiving amateur radio in speech (SSB) and Morse code doesn’t differ too much from broadcast reception, I will concentrate on digimodes which need some extra software to decode.

Digital speech using **FreeDV** is somewhat new, but I have received and decoded some station on weekends near 14.236 kHz using FCD and **FreeDV** with most promising results. Click to the loudspeaker icon to listen to a CQ call of EI3FW, in FreeDV, just received that way.



## Amateur Radio: Digimodes

Digimodes play a growing role in amateur radio. There are literally dozens of modes, hence dozens of software to deal with them. On the following pages, I want to give exactly just a dozen of examples for a variety of digimodes. Nearly all are received in USB mode. I will also use a variety of software which is fed by the audio output of FCD. For your monitoring, I recommend to pick some favorites for future work. Although being not purely digital, also e.g. analogue SSTV has been listed here because this needs a digital decoder.

## RTTY

Baudot with a rate 45,45 Baud and 170 Hz shift is the eldest truly digital mode in the amateur radio bands. Here received with **MMTTY** software.

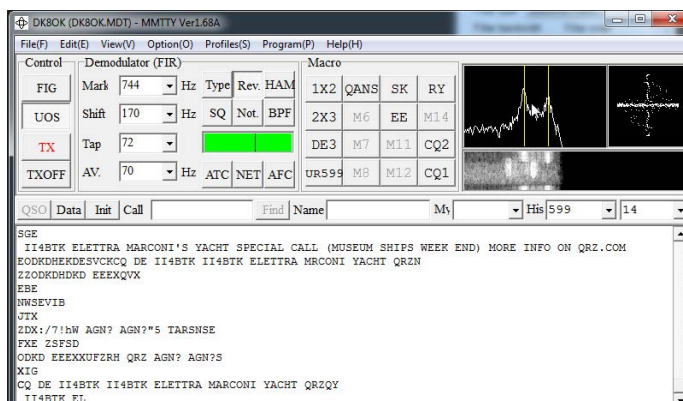

Figure 9: Reception of I14BIK from “Elettra”, the yacht of wireless pioneer Guglielmo Marconi.

## WSPR

**WSPR** is a narrow mode (and: software) using 4FSK modulation. Thanks to its waveform and the slow baud rate, it can span the globe with just a few ten milliwatts on a modest antenna. 10.138,7 kHz is on popular “cluster”-frequency, and WSPR software will automatically decode all signals within the audio passband.

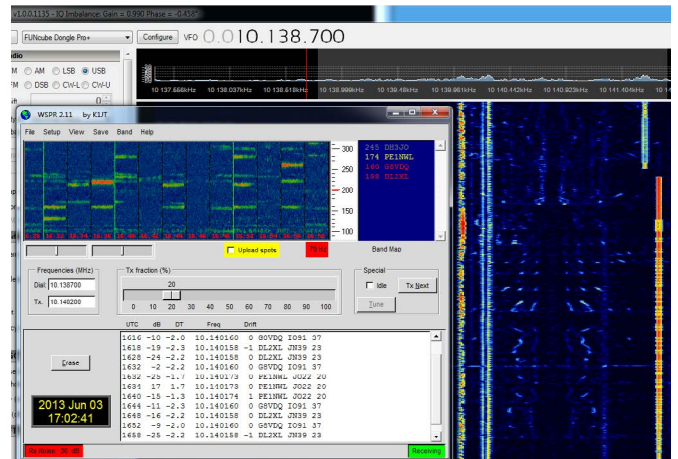

Figure 10: WSPR reception on 30 m.

## Olivia

Olivia is a MFSK mode with four to 64 tones and bandwidths from 250 Hz to 2 kHz. Usually it is transmitted on full kHz’, e.g. 14.108 kHz. **Fldigi** is the software used here. This is the software of choice not only for Olivia, but nearly all modes used with ham radio. It’s easy to control and convinces with excellent decoding results.

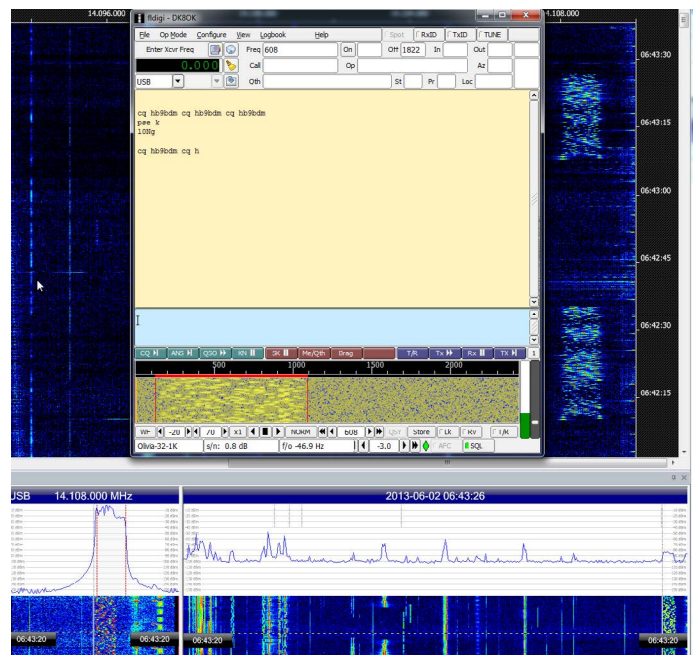

Figure 11: A CQ call of Swiss ham HB9BDM in Olivia. You see the sonagram on the right. Signal was played from a I/Q-file of FCD with SDR Files Analyzer.



## MFSK16

MFSK is another mode with multiple tones. The range spans four to 128 of them. A CQ call is mostly placed in MFSK-16 with 16 tones within a 250 Hz bandwidth. **Fldigi** is used here as decoder.

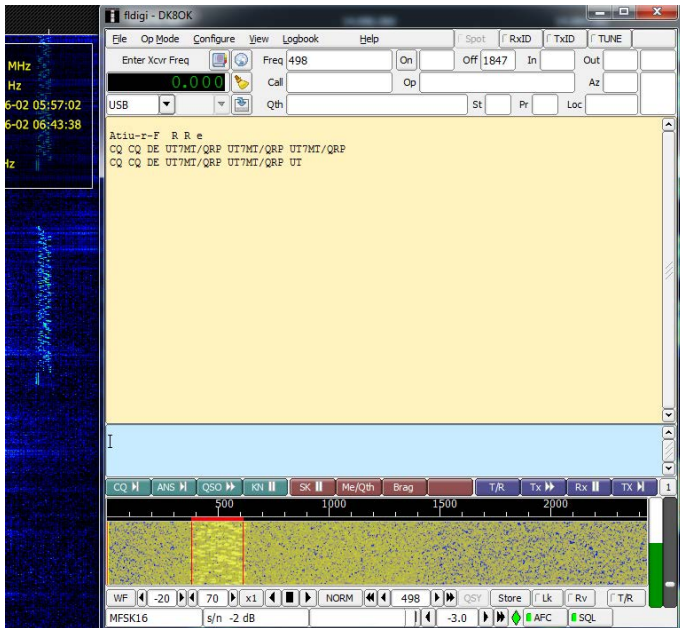

Figure 12: A CQ call of Ukrainian ham UT7MT in MFSK in low power (QRP). You see the sonagram on the left. Signal was played from a I/Q-file of FCD with SDR Files Analyzer.

## PSK31

PSK31 still is the most popular digimode. It is transmitted in 2PSK, and the bandwidth is just 62 Hz. That allows for packing many stations in a relatively small band. One major activity frequency is around 14.070 kHz. **WinWarbler** is among these decoders which decodes many stations in parallel within the audio band. It lists them automatically by their call sign, relative (audio) frequency and some other data plus their content.

Figures see next column.

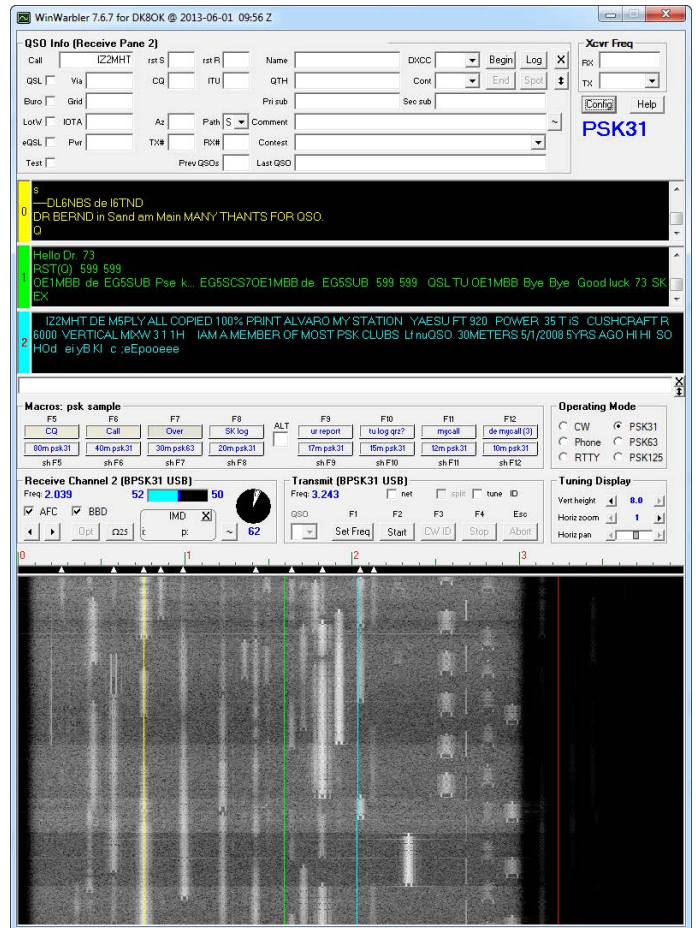

Figure 13: Winwarbler detects many PSK31 signals, each marked by a triangle above the sonagram. The software decodes them all in parallel ...

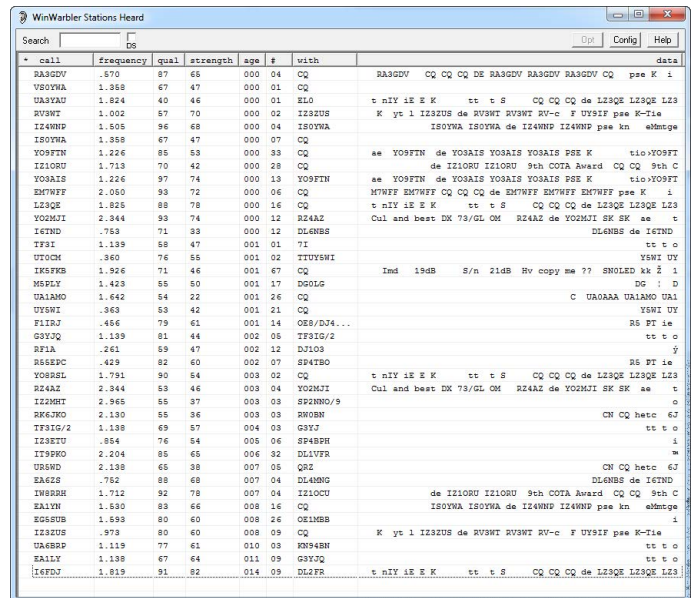

Figure 14: ... and lists them with their call signs, decoded text and much more data in a separate window.



## Factor

Factor is a professional and adaptive mode. In its original implementation it needs a proprietary hardware modem and proprietary software. Free software can read Factor-I to Factor-III. Most recent mode Factor-IV still is another story at this time – even for professional decoders. As no free software automatically follows the possible different sub-modes of Factor during a transmission, it's a proven idea to open several instance of [Sorcerer](#) decoder, each with a different decoder: Factor I, Factor II and Factor III.

As most Factor is with mailboxes, it is often heard in ARQ mode. That is: One station (“Information Sending Station” ISS) transmits the information in “packets”, whereas the “Information Receiving Station” IRS is checking each packet, acknowledges it or asks for repeating a faulty received one. The reception quality between two stations rarely is the same as for the listener in between. This can result in a mixture of clear text and rubbish. But don't mix up binary files (e.g. FAX) as rubbish!



Figure 15: Contact in Factor-III to HB9MM, Winlink station in Lausanne/Switzerland.

## AX.25 HF or Packet

Packet Radio in ham radio consists of an extended X.25 protocol by CCIR. The information is sent in “packets” (hence the name) in 300 Baud/FSK with 200 Hz shift. Most activity is noted by so-called Packet Radio Boxes, e.g. just above 14.100 kHz. Among free software, [Sorcerer](#) is the decoder of choice.

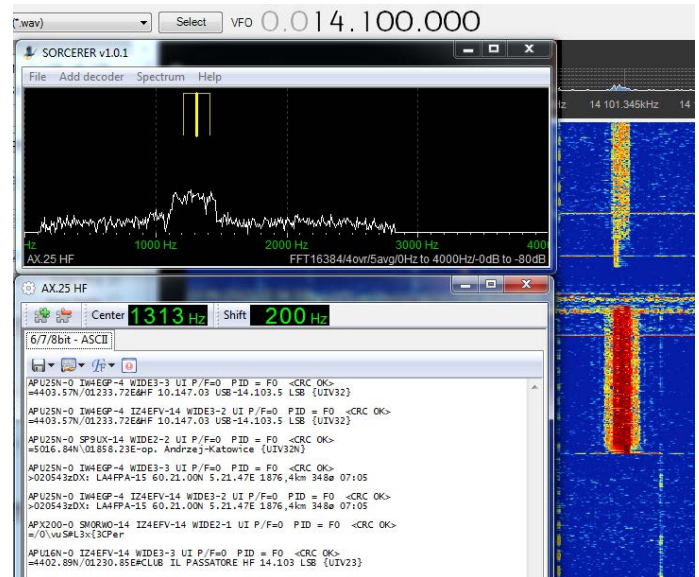

Figure 16: Some Packet activity on 20 m. You see the sonagram on the right.

## Hellschreiben

Hellschreiben is a FAX-like mode, nowadays only rarely used by hams. [Hellschreiber](#) by IZ8BLY is (de) coding a couple of different tastes of this mode, which has been used since its development in 1929 by Rudolf Hell for many years by the professionals to overcome severe selective fading. If you now find a ham in Hell, the mode will be mostly “Feldhell”.

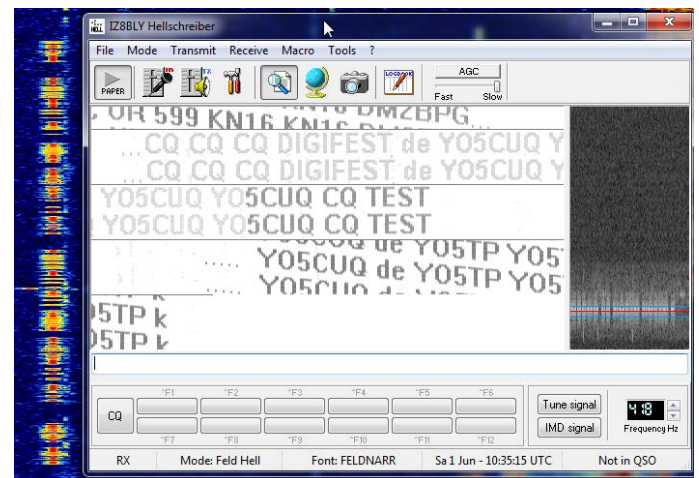

Figure 17: Feldhell in the 20 meter band. Characteristic is, it's written in two redundant lines. That makes easy reading even if there is no perfect synchronization as seen here. Originally, decoded text was inked onto paper slips.



## ROS

ROS is a Multi-FSK mode, developed for small transmitting power to cope with bad channels. It incorporates a bridge into the internet with e.g. a propagation map. ROS-Modem ROS by EA5HVK is the only free software around for this mode.

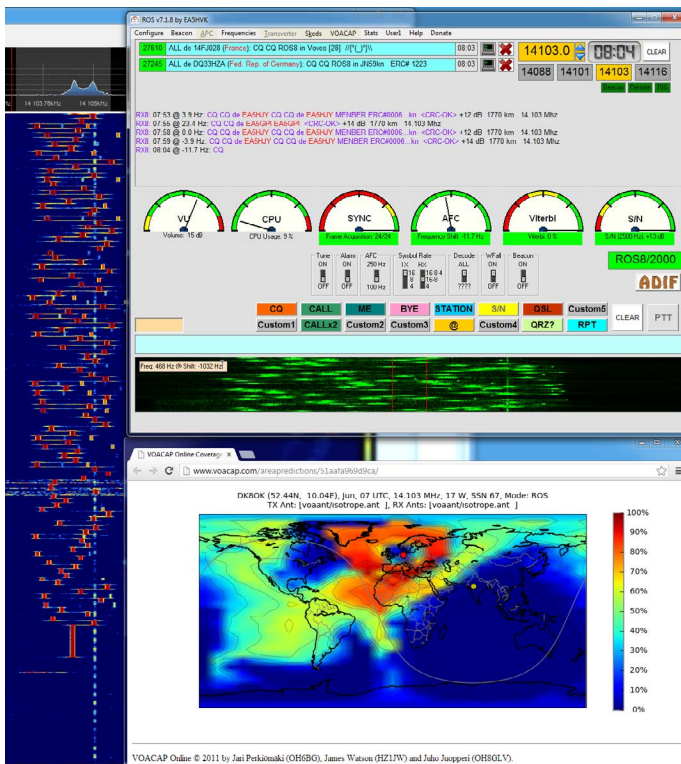

Figure 18: A view onto some ROS signals on 20 m. Below the ROS software, you see the propagation of a ROS signal by VoACAP, loaded by just one mouse click from the internet.

## SSTV analogue

Slow-scan television is a FAX-like mode to transmit pictures by successive lines. There have been developed many waveforms and protocols, nowadays “Martin” and “Scotty” seem to be most popular. A software like MMSSTV detects the kind of mode automatically and changes to it for decoding. 14.230 kHz and around is one of the most busy frequencies for SSTV.

Figures see next column.

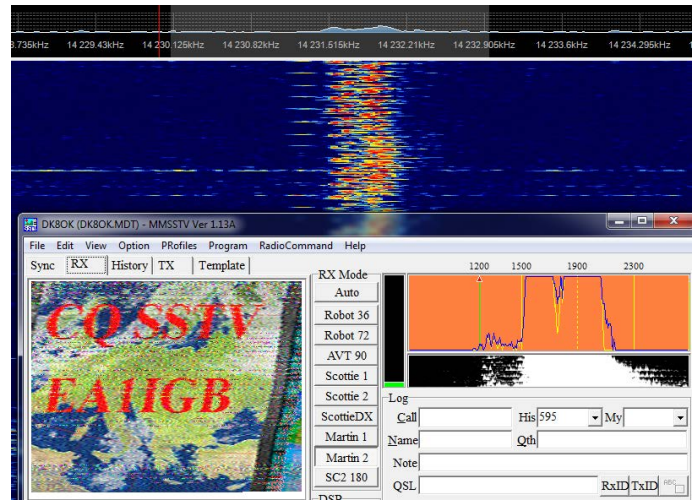

Figure 19: Spanish ham EA1IGB calling CQ in Martin2 mode.

## SSTV digital

Digital SSTV is using DRM mode (see page 4), originally developed for digitizing shortwave broadcast. It has been adapted for the bandwidth to be used by hams. The noise-like Coded OFDM signal consists of 48 data carriers each modulated with 37,5 Baud and three pilot carriers at 725 Hz, 1475 Hz and 1850 Hz. There are several waveforms, but even under good conditions hams prefer the lowest being QAM. EasyPal is a wonderful software for transmit, receive and even analyze such signals. The pictures themselves will appear only at the end of the transmission. If most of the information was received correct, you get a crystal clear picture. 14233,0 kHz is a frequency to usually find some activity.

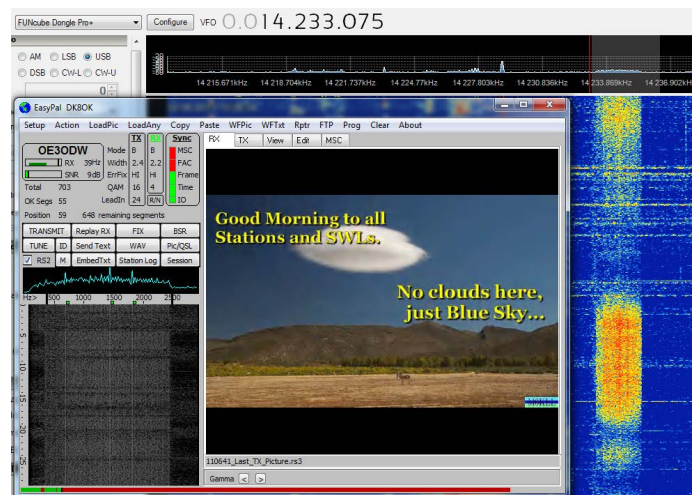

Figure 20: M0KLL has sent a digital photo, whereas the picture of OE3ODW still is being processed.

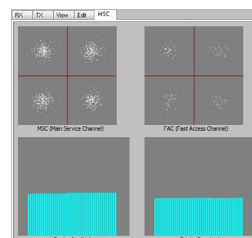

Figure 21: Phase planes of the OFDM signal, made by EasyPal.

## Utility – the next “Big Thing”

On the past pages, I covered broadcast and amateur radio. The following pages will deal with a third species, utility radio. That is what is left by the other two species: maritime radio; aeronautical, military and diplomatic communications. Some of these are in phone (mostly SSB, upper sideband), a few in morse codes, and the most in different digimodes.

Many transmitters and transmissions do carry plain text – at least for their identification. On the other hand, much communication is encrypted: you can demodulate the bit stream (e.g. groups of five numbers) but not decrypt it to a readable text. Any professional who wants to keep his communications secret will encrypt it. In turn, each open communication can be *prima vista* regarded as “CQ” or “for all”. Many stations even do verify reception reports.

Thanks to elaborated decoder, there is a real wealth of stations which can be read. As we see more and more broadcasting stations closing down, utility DX can be the “next big thing” among DXers. It’s also very interesting from a technical point of view.

On the next pages you will find some examples of what can be received and decoded with FCD plus free software. I would like to recommend [UDXF](#) and their active Yahoo Group for anyone who wants to splash deeper into this field. It is far beyond the scope of my task to give a general introduction into utility DXing.

## Aero

In the aero bands, we find speech as well as data, sometimes even combined. Start with weather reports (VOLMET) in USB. They are transmitted from many airports around the day at scheduled times. [Click here](#) for a list of airports, times, and frequencies.

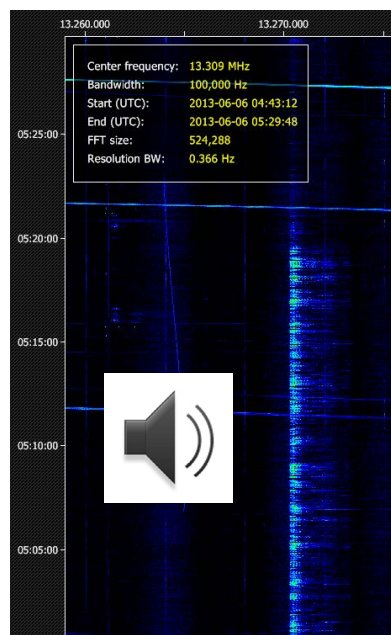

Figure 22: Sonagram of New York Radio's VOLMET broadcast on 13.270 kHz.

Click the loudspeaker symbol for listening!

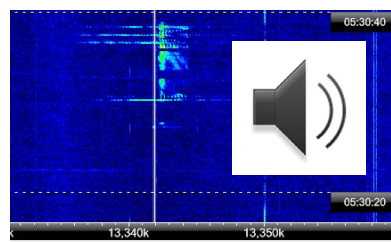

Figure 22: Sonagram of Stockholm calling on 13.342 kHz.

Click the loudspeaker symbol for listening!

Proceed with speech communications ground to air and vice versa. Sometimes only on leg of this highly elaborated communications can be heard (example above). During these checks, the ground station is often calling the aircraft by its selcall (*Figure 23*). This four-letter code is transmitted in AM with full carrier, but only in the upper side band. Each letter from A to S is coded by one of 16 tones. [Sorcerer](#) decodes them.

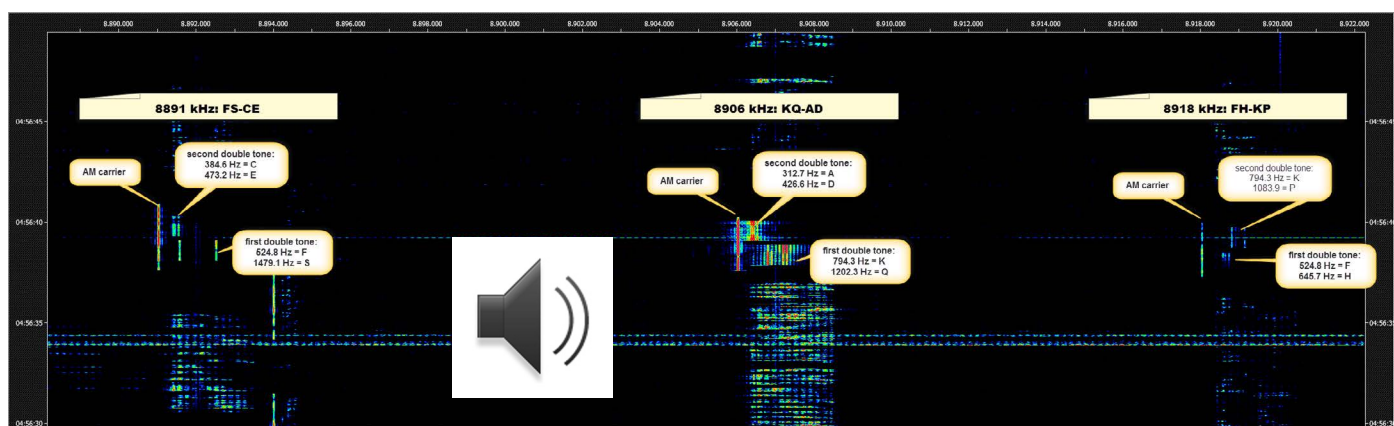

Figure 23: Three selcalls from three ground stations (Shannon, Gander and Cayenne). They are received in AM. Click loudspeaker icon for audio!



## HF Data Link or HF ACARS or ARINC-635

This global system is provided by **ARINC** and is backed by a net of HF ground stations. Communications between ground and air is established in “packets”. Ground and air are heard from each part of the globe if conditions permit. [Click here](#) for further information and a frequency list.

As decoder, I am using **PC-ALE** with best results under even severe fading.

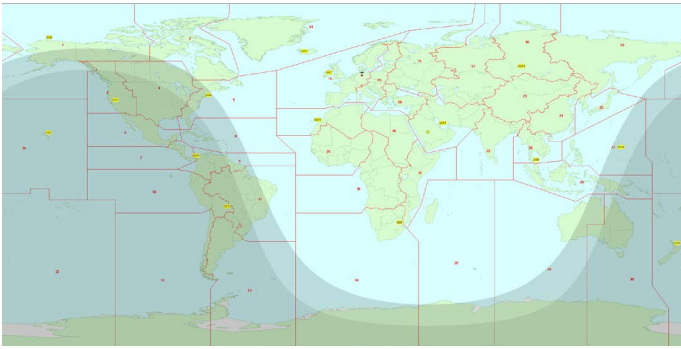

Figure 24: ARINC’s HF ground stations (GS) are scattered all over the world. Map has been made with DX Atlas.

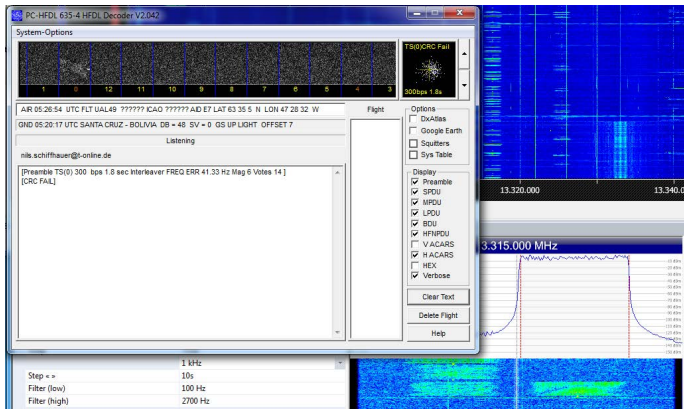

Figure 25: ARINC Santa Cruz/Bolivia on 13.315 kHz ...

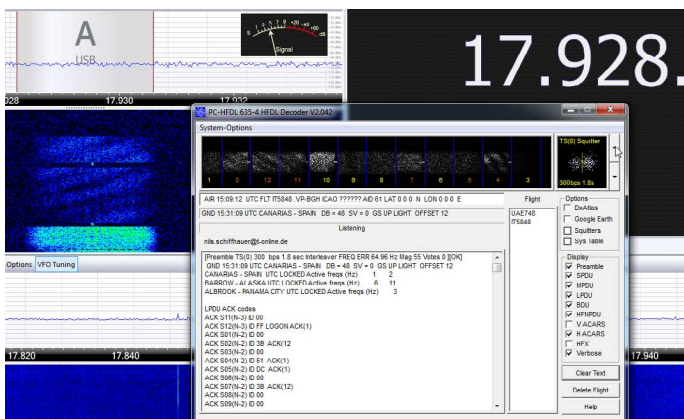

Figure 26: ... and ARINC from Tenerife/Canary Islands on 17.928 kHz

## Maritime Communications

Since the Titanic, maritime communications plays a most vital role on HF. Today we find speech as well as data and even some forgotten morse code.

### SSB

Speech communications is found on the speech channels. Many stations are also transmitting weather reports at scheduled times and frequencies. Monaco Radio e.g. starts this with their anthem, always reminds me to “Freedonia” in “Duck Soup” by the Marx Brothers, 1933 ...

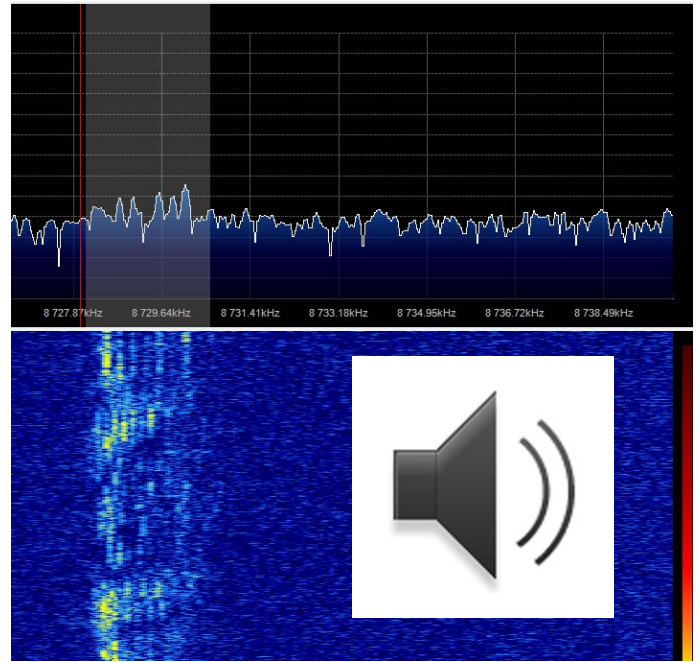

Figure 27 (click on loudspeaker icon): Start of Monaco Radio’s weather broadcast on 8.728 kHz at 09:30 UTC.

### Morse Code or CW

Although officially wiped out of the maritime bands since mid-1999, we still find some users like Israeli or Pakistan Navy (Figure 28, below) or Japan Fishery Radio. There are some automatic CW decoders around for free (like **Fldigi**), but noise make their use difficult with weak and manually given signals.



Figure 28 (click for audio): DX CW signal of Pakistan Navy on 6.391 kHz, reading: VVV VVV VVV AQP 1/4

CW is also in some use for identifying stations, e.g. giving their call sign in morse code between some data packets, see Figure 29, next page.

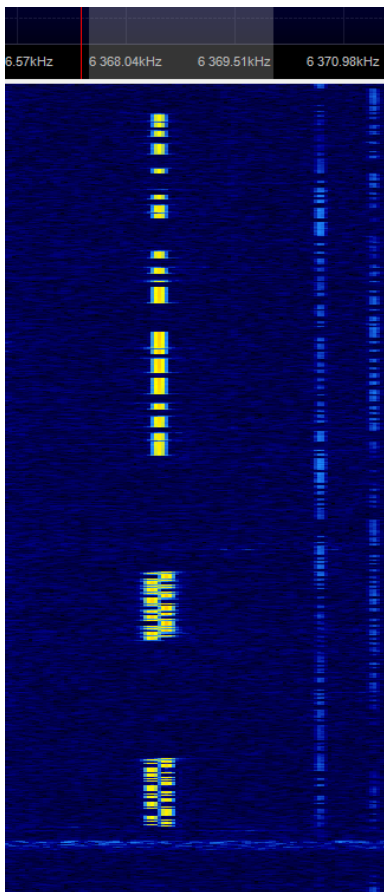

Figure 29: Berne Radio HEB from Switzerland is one of the stations identifying in morse code, here after two Pactor packets.

Click into the loudspeaker icon to listen to this signal!



## DSC or GMDSS

This digital selective calling system (DSC) is part of the [Global Maritime Distress and Safety System](#). The short transmissions in FSK (170 Hz shift, 100 baud) are found on the following HF GMDSS frequencies: 2.187,5 kHz, 4.207,5 kHz, 6.312 kHz, 8.414,5 kHz, 12.577 kHz and 16.804,5 kHz. I used [Sorcerer](#) to decode these signals. There you have to look up the MMSIs or call sign-like Maritime Mobile Service Identity numbers manually – [click here](#) to do so for ships and [here](#) for coastal stations. See [Figure 30](#).

## SITOR-A and SITOR-B

Simplex Teletype Over Radio, or SITOR, comes in two flavors: SITOR-A is a packet-like automatic request mode, hence also dubbed “ARQ”. It provides a communications between two stations with only few chances of errors, because it automatically repeats wrongly received packets. SITOR-A is only for point-to-point communications.

In contrast, SITOR-B or FEC is a broadcast mode and used for weather etc., see [Figure 31](#), next page. It transmits continuously and corrects many errors simply by redundancy, a bit misleadingly termed “Forward Error Correction”.

AMTOR is an adaption of this modes for the special purposes of ham radio.

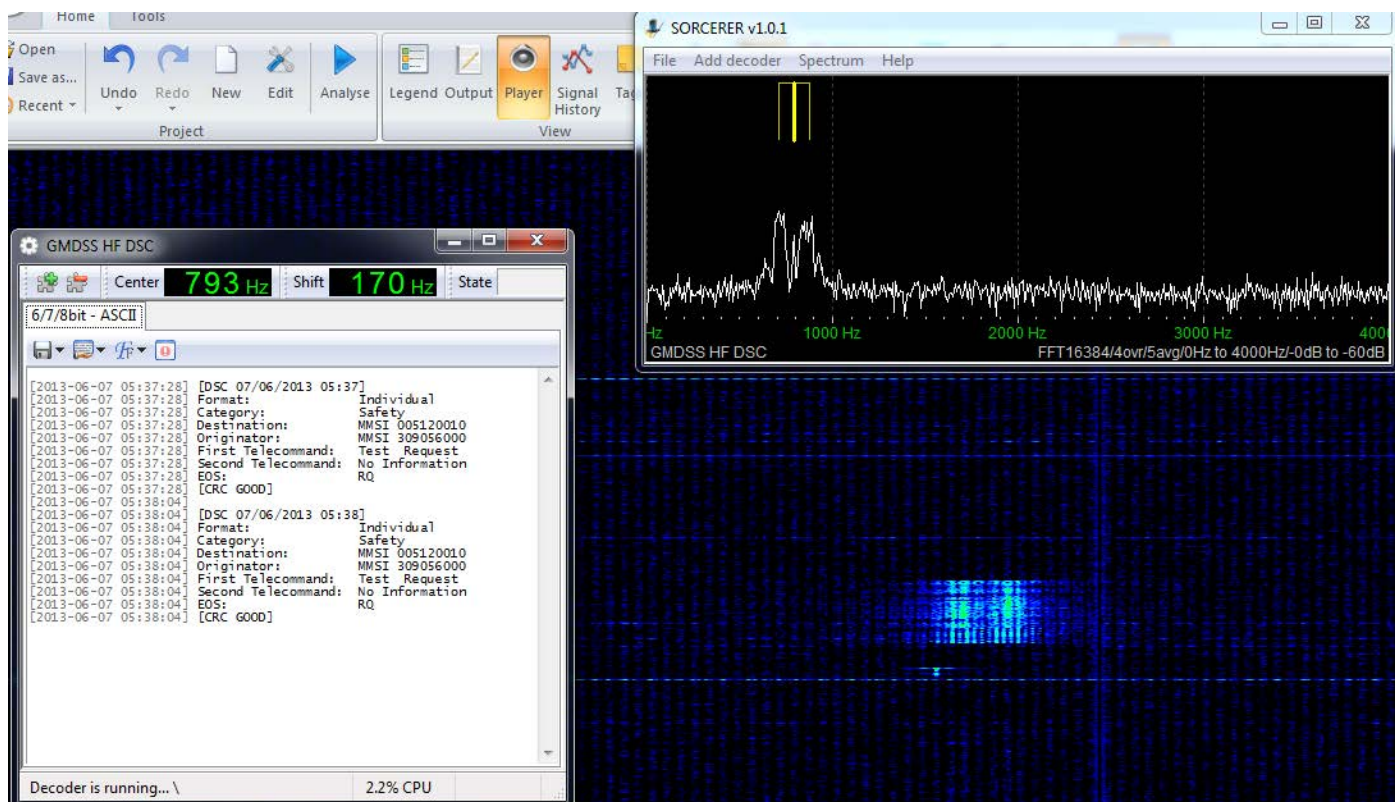

Figure 30: On 12.577 kHz, passenger ship “Wind Spirit” (MMSI 309056000) is calling Taupo Radio, New Zealand (MMSI 005120010).



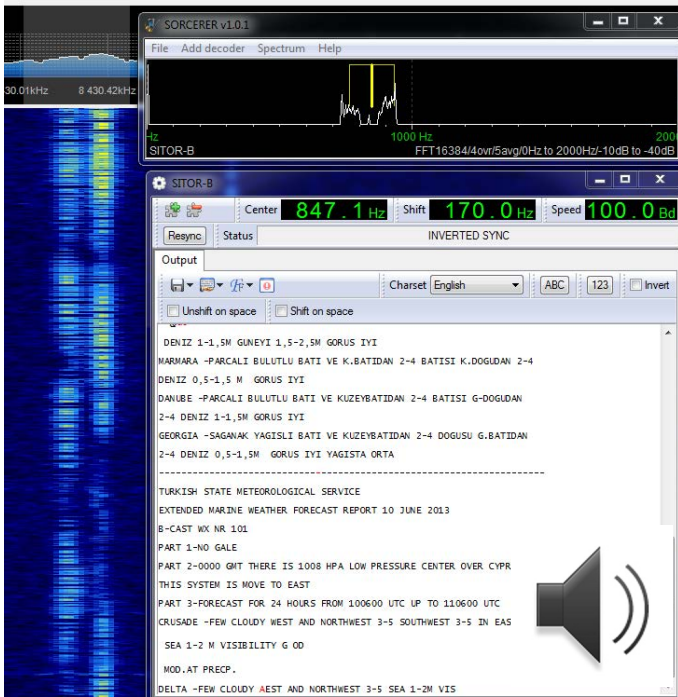

Figure 31: Istanbul Radio TAH with weather report of Turkish State Meteorological Service 8431 kHz in SITOR-B, decoded with Sorcerer. Click onto the loudspeaker icon for audio!

### Globe Wireless et al.

Globe Wireless is an globe-spanning organisation with around 25 coastal stations. They transmit e.g. a channel marker in GW-FSK (similar to SITOR-A) and communicate in GW-PSK and GW-OFDM.

GW-FSK can be decoded e.g. by Rivet software (see Figure 32), GW-PSK by Sorcerer, but for GW-OFDM there is still no free software around.

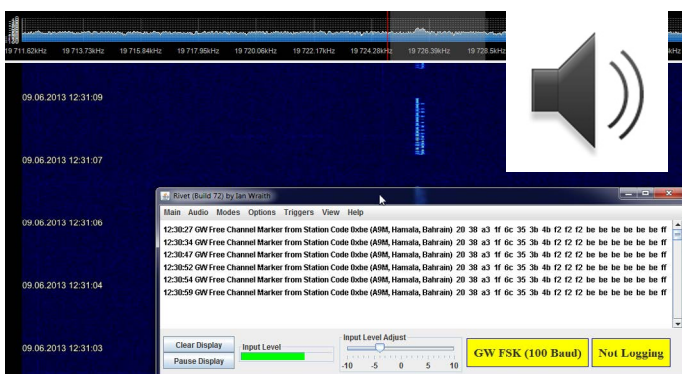

Figure 32: Globe Wireless station A9M in Manama/Bahrain with an FSK channel marker, decoded by Rivet software. Click on the loudspeaker icon to hear the sound.

There are also some other networks to provide communications in a similar way: SailMail and the Maritime Communication HF Network. They also do use a similar protocol, Pactor. See Figure 33 for an example.

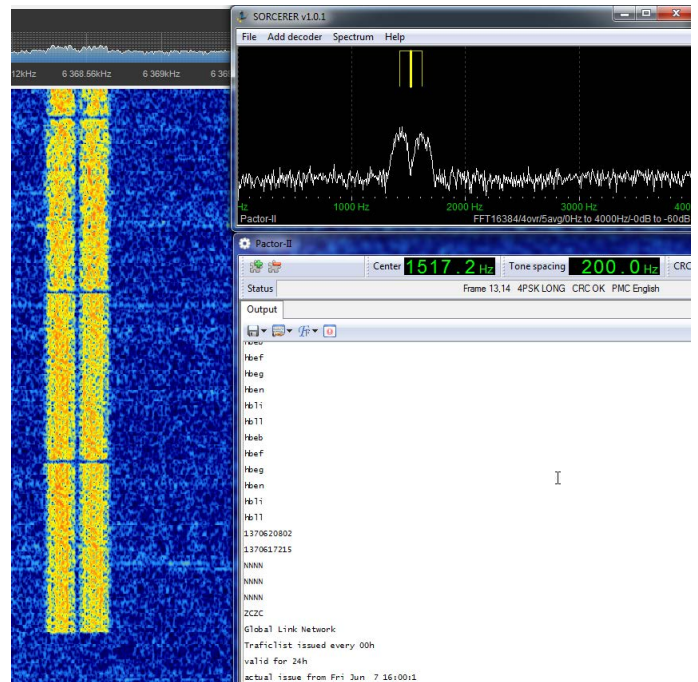

Figure 33: Traffic list of HEC on 6.367 kHz in Pactor-II, decoded with Sorcerer.

### Time Signals

Yes, the number of stations, providing exact time and frequency, has been thinned out in the last years & decades. But some of them are still beeping. Allocated frequencies like 2.500 kHz, 5.000 kHz, 10.000 kHz and 15.000 kHz are worthwhile to check conditions into Colorado, Hawaii, China, Brazil etc. They often carry also digital time codes to control wireless clocks, like WWV/WWVH (see Figure 34).

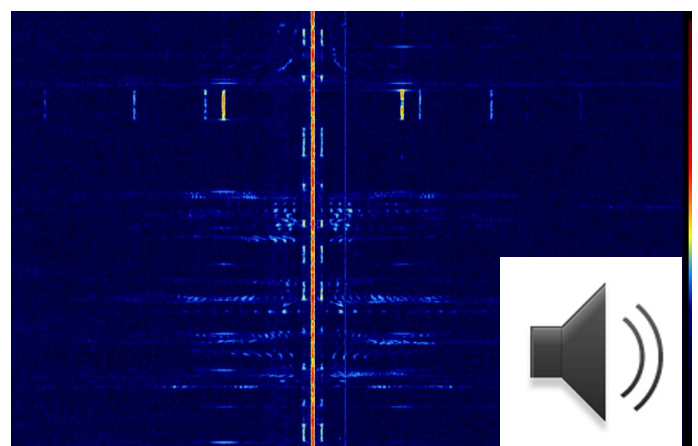

Figure 34: 15.000 kHz with WWV/WWVH and BPM. In the foreground WWV. Left and right from the strong carrier you see e.g. the sub-carrier (100 Hz) with the BCD time code, some speech modulation and the longer minute markers at 600 Hz.

Click on loudspeaker symbol to listen to the full announcements of WWVH (female voice, weaker) and WWV (male voice, stronger) on the hour on 15.000 kHz.

## Other modes, other services

In this chapter, I will give a few further examples of digital modes which can be received by FCD and decoded with free software. It is meant for triggering your own discoveries.

### ALE - Automatic Link Establishment

This 8FSK transmission is widely heard on HF. ALE is a great tool to automatically pick the best frequency out of a set of channels to establish communications between two stations. This following communication then is under another digital or even analogue mode. An ALE call consists at least of a (tactical) call sign. This and its proliferation makes it also very attractive for listeners.

You find ALE signals everywhere, even in midst some broadcast bands. A big, global and reliable network with some attractive locations is that of US Air Force and Navy, the HFGCS. [Click here](#) for details, including frequencies and working times.

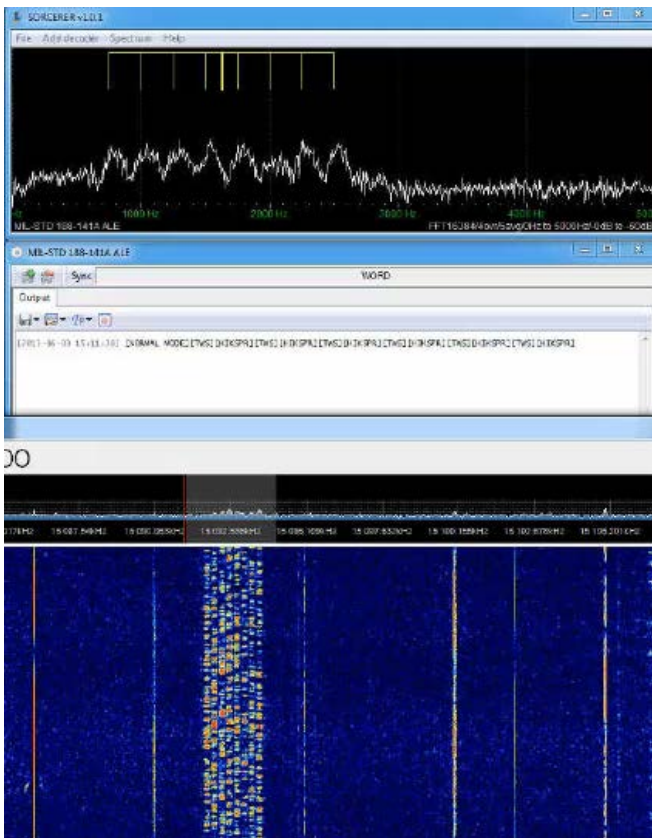

Figure 35 (click for video): Station "HIKSPR" received on 15.091 kHz, decoded with "Sorcerer". The ALE call signal stands for US Air Force, Hickam Air Force Base, Hawaii.

## Baudot or RTTY

This old 2FSK mode still is used by some services, e.g. Deutscher Wetterdienst. Rivet software copes with many of different shifts, baud rates and other specifications. There are a couple of Russian signals which sound like RTTY but most of them are encrypted.

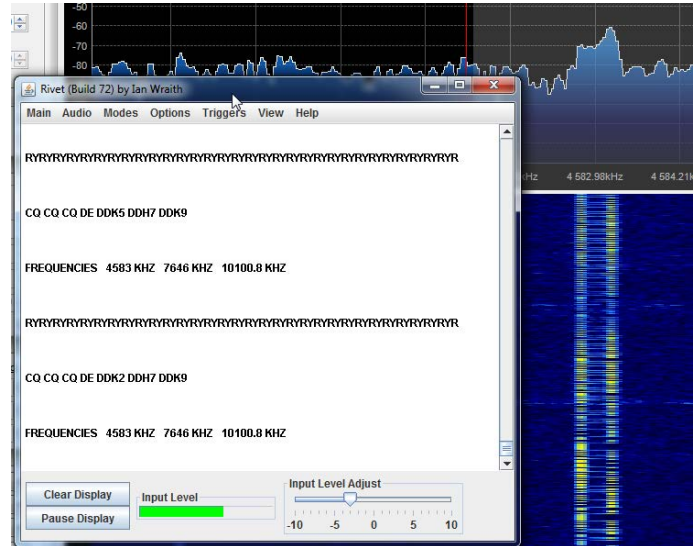

Figure 36: Test transmission of Deutscher Wetterdienst on 4.583 kHz in 2FSK, baudot, 425 Hz shift, 50 Baud, 1,5 stop bit.

## FAX

FSK-like mode to transmit weather charts and some news in Japanese (see below, noisy at bad conditions). There are some 25 stations around worldwide, and they can be decoded with Fldigi. Sometime the synchronization can slip so that you have staircases in the picture, as one below.

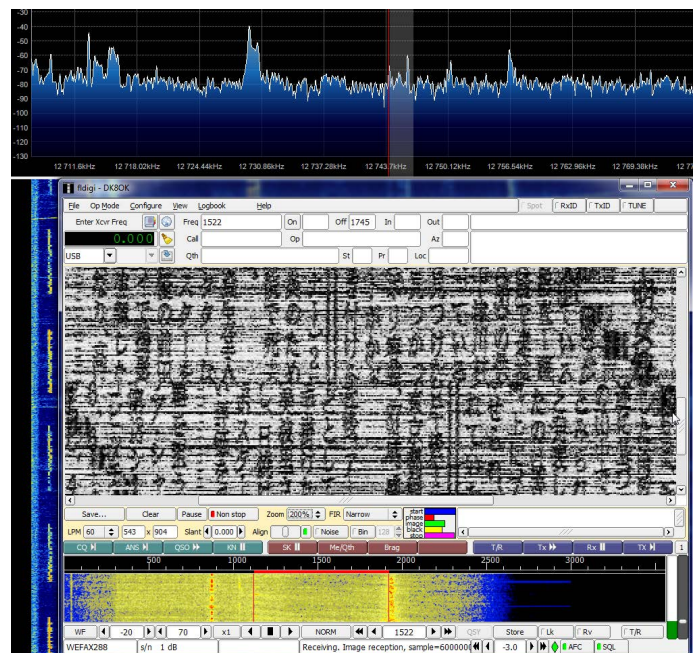

Figure 37: KYODO News Agency, 12744,5 kHz



## STANAG 4285

This waveform is a common one on shortwave. It is widely used by the military in different flavors. Most easily are decoded the test transmission from the French Forces from many location as Senegal, Tahiti, Reunion, New Caledonia or Djibouti. **Sigmira** is an excellent free decoder for this mode, outperforming even some commercial ones under selective fading, see *Figure 38*. This 8-PSK signal at 2400 baud needs an exact tuning within the range of a few ten Hertz for best copy.

There are many more modes on shortwave. Some can be decoded with free software, other not. And there are some strange looking traces, *Figure 39* and *Figure 40* show two examples.

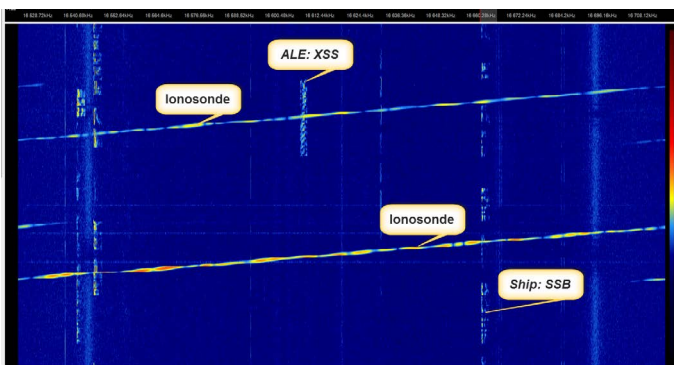

Figure 39: Two analogue ionosondes.

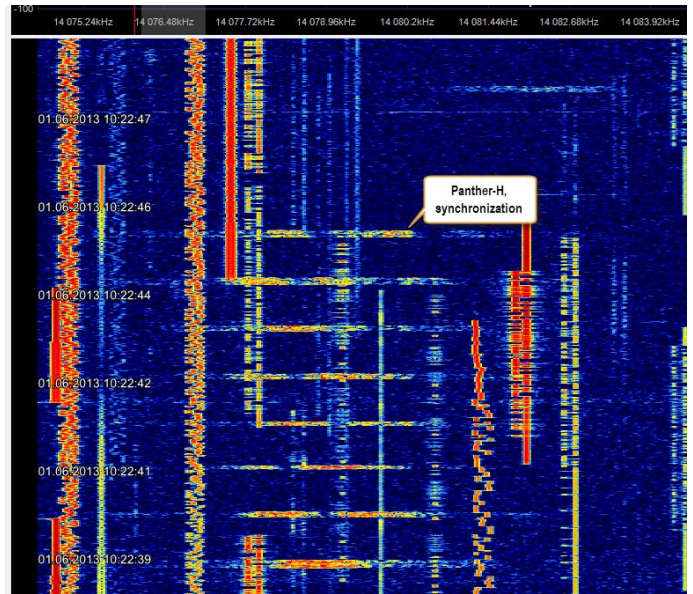

Figure 40: Eight short pulses on one frequency mark the start of frequency-hopping in the mode "Panther-H".

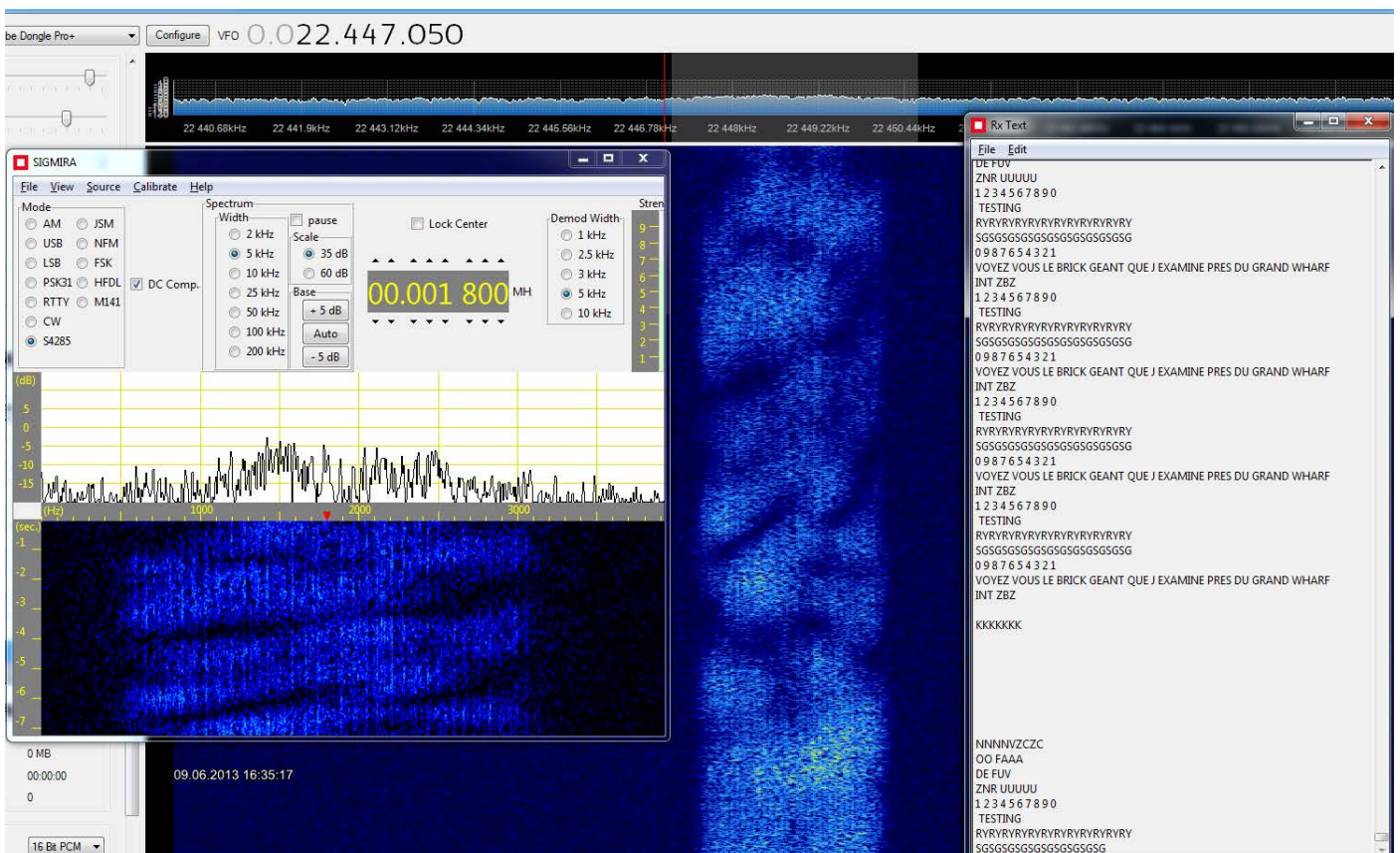

Figure 38: French Navy Djibouti testing on 22447 kHz in STANAG 4285. Decoded with Sigmira, giving excellent results even on this noise and fading channel



## Record, Play and Analyze

Just a very few words on record, play and analyze, as their detailed story would easily fill a book ...

### Record and Play

Software [SDR-COMV2](#) of Simon Brown offers recording of I/Q or signal for up to 48 hours in “chained” files of each up to 2 GB. One hour of a 192 kHz wide recording results in about 2.3 GB.

For analyzing these files, “SDR Data File Analyzer” jumps in. It is a module of [SDR-COMV2](#) software which can be separately used. It shows the whole recording in a sonagram. In this sonagram you can simply point and click into a signal and listen to it. You may also zoom both frequency and time. *Figure 41* shows such a sonagram of the lower part of the 20 m amateur radio band. It also carries the correct (original) time stamps (SDR# doesn't, but takes that of the PC during play).

In my view, this is one of the most mighty tools every developed to have an overlook onto a broad frequency region during a given time span. And it is an ideal tool to catch short-timed signals like ALE or to identify just that time where a signal is strongest and/or gives best reception thanks to least interference.

For some other software please see e.g. [DSP Radio](#) by Sebastian Mrozek (Mac) and [SdrDx](#) for Mac and Windows.

## Analyze

Thanks to different FFT resolutions, all SDR control software provides efficient tools to take some measurements mainly in the *frequency* domain of a signal (e.g. mains hum, shift of FSK signals, harmonics ...). What is often missed, are similar precise measurement on the *time* domain.

Here you need an oscilloscope software. Among free software, I recommend Christian Zeitnitz' [Soundcard Oscilloscope](#) for this purpose. See *Figure 42* for an example. This software is also a great tool to measure *frequencies* with cursors.

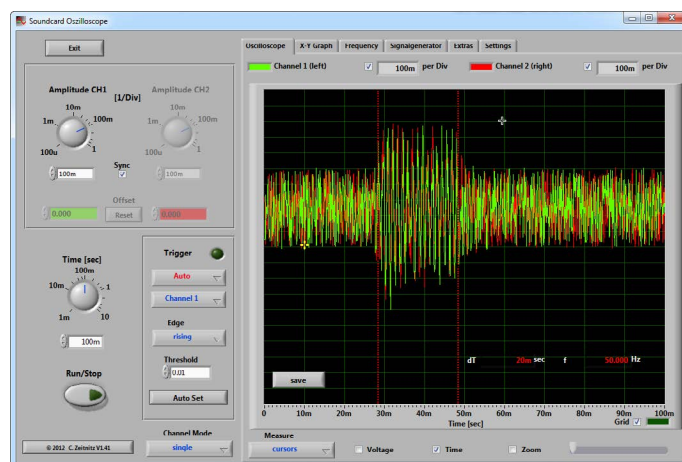

*Figure 42: One pulse of time signal station RWM/Moscow on 14.996 kHz is measured at 20 milliseconds length.*

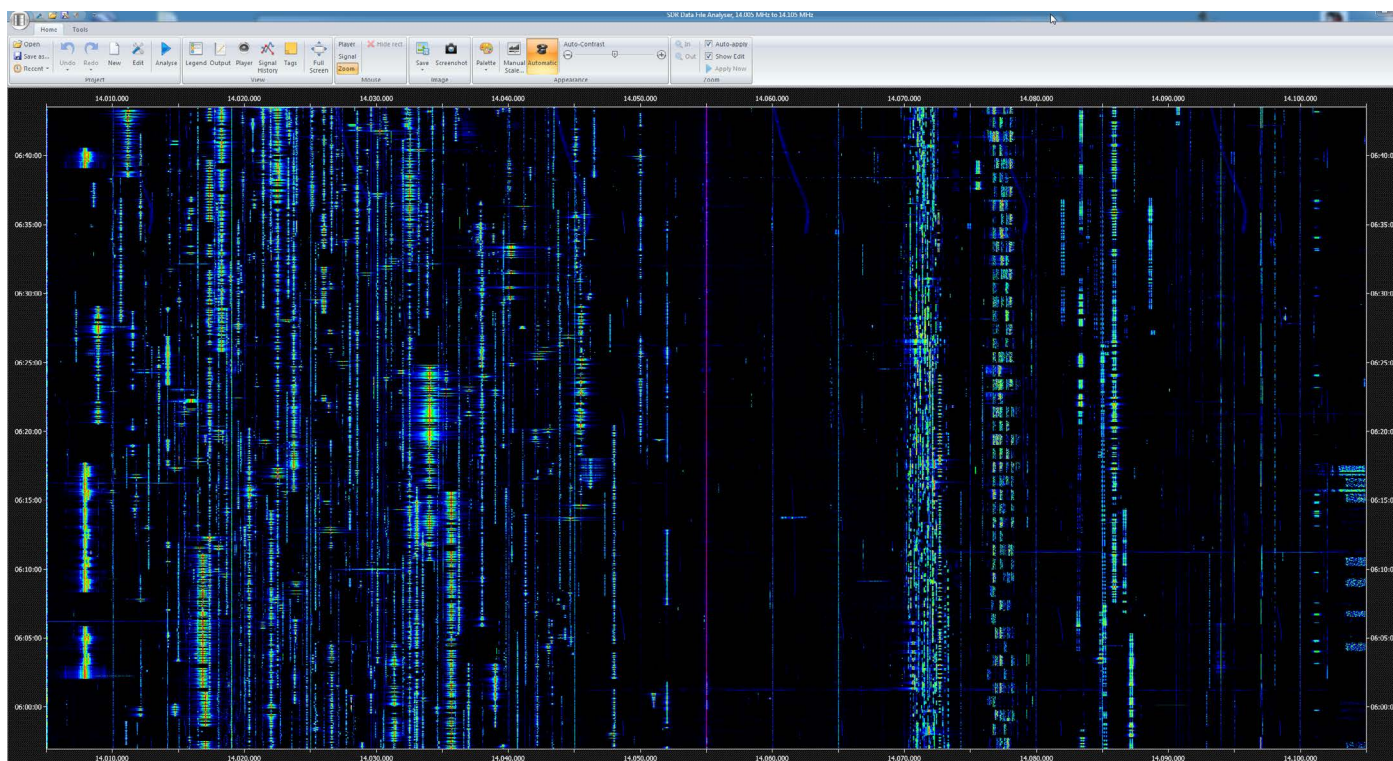

*Figure 41: 46 minutes of the lower part of 20 m amateur radio band as sonagram. As this sonagram “lives”, you may simply point and click to any signal to hear it.*



## Some results

FunCubeDongle PRO+ V2 can be considered as a cheap and serious tool also for shortwave listening. With free software, it provides a monitoring post, shortwave listener couldn't have imagined some ten years ago.

For best results, you have to keep strictly within the dynamic range of the receiver. If you overdrive it, you simply get ghost signals. You can not correct them at a recording!

Given this, the receiver is an impressive tool with a compatible sensitivity, even for some demanding DX. What started a bit skeptic ("Form factor and price - might that work in general on shortwave?"), ended up in standing ovations for [AMSAT UK](#) and the designer of all software used for this paper.

These, at least: me, surprising results also lead to some conclusions about the future of journalism in this field: In my opinion, future receivers will be considered mere modems with more or less same specifications. All other things will be defined by software. This will drive users' attention more to applications ("How do I have fun with this stuff?") than just to scrutinize dBs and microvolts. Since five years or so this is no news for hams which are interested in state-of-the-art technology. But for most of the ham radio press this is a change paradigm and a change of business model, because they may no longer not rely on beefy revenues from Yaesu, Kenwood and Icom which obviously show no activity in this field and leave it open for start-ups with great ideas but often little money to spend for advertising.

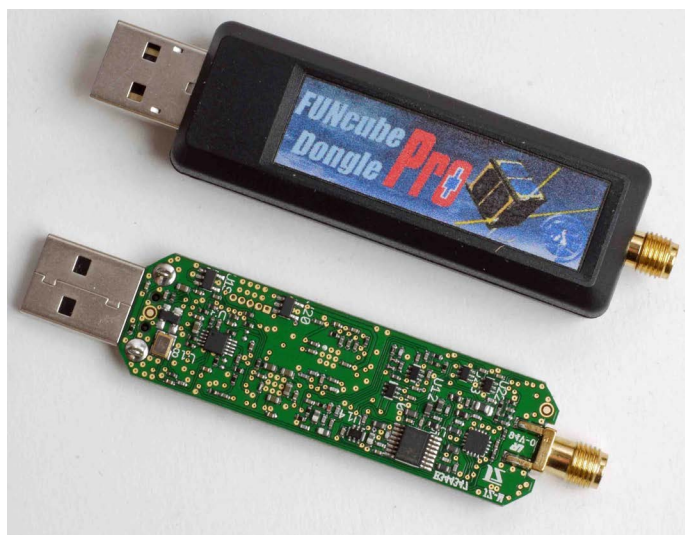

Figure 43: FunCubeDongle PRO+ V2, a great little tool!

## This Paper: Why and How

This paper has been written to show some potential of shortwave reception which can be opened with just a cheap receiver and even free software.

*All examples had been recorded exclusively with FunCubeDongle PRO+ V2 and free software in May/June 2013 in Germany.* Only for some comparisons, there are some audio files included, which were done with Winradio's ExcaliburPRO.

With its combination of text, audio, video and many screen shots it should also serve to present and to discuss a somewhat new form in presenting such findings in a way being state-of-the-art and easy to follow.

I vividly want to encourage to see it as a suggestion on how a paper-based magazine can be enriched with additional information. I am convinced that this multimedia approach is quite attractive to newcomers as well to oldtimers. You can simply print and read it like a paper-based magazine, or you can read it at a PC/MAC to additionally make use of its multimedia contents.

The paper has been written and (a bit too roughly) laid out with [Adobe's InDesign CS6](#). Screen shots have been made and annotated with [SnagIt](#), videos with [Camtasia Studio 8](#). Audio recordings were made with [Audacity](#), and processed/converted with [Adobe's Audition CS6](#). Of course, for each purpose other software can be used, e.g. the excellent [BB FlashBack](#) software to take screen videos.

The paper has been exported into Adobe's PDF and tested with the most recent Adobe PDF Reader on numerous Windows' OS as well as on a Mac.

Your comments are highly appreciated: [click here](#) for sending me an e-mail.

**Nils Schiffhauer**, born 1955, is shortwave listener since the late 1960s and gained DXCC Honor Roll under his call sign DK8OK. He published around 800 articles and 25+ books on the wireless hobby. Owning an M.A. degree in historic science and literature, he works as journalist for science and technology for papers like Frankfurter Allgemeine Zeitung and Technology Review. He is also doing corporate publishing for leading German companies ("DAX30") in the field of science and technology. He has been thrown out of Germany's amateur radio club DARC e.V. because he strongly voted for a code-free HF-license in the 1990s. After having had published for more than 30 years in all major German wireless magazines, he subsequently was and still is being boycotted by all of them.